

**BOTTOM-PLAN VIEW (TOP ONLY)**

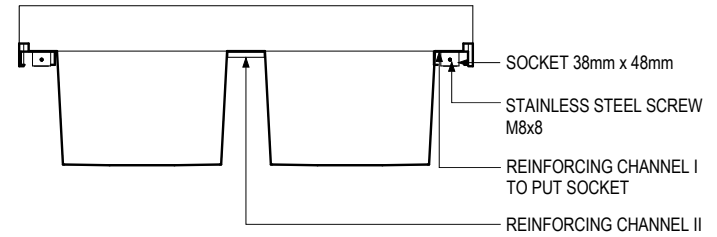

**A-SECTION VIEW  
SCALE 1:15mm**

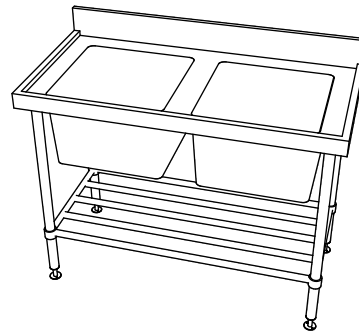

**ISOMETRIC VIEW  
do not scale**

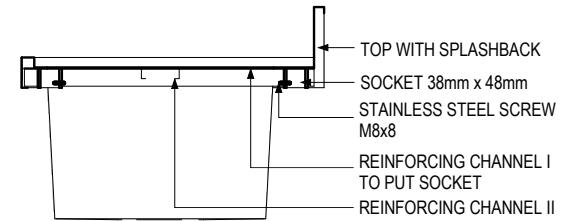

**B-SECTION VIEW  
SCALE 1:15mm**

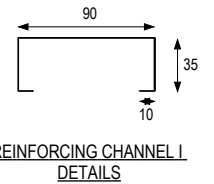

**REINFORCING CHANNEL I  
DETAILS**

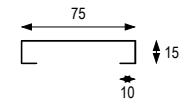

**REINFORCING CHANNEL II  
DETAILS**

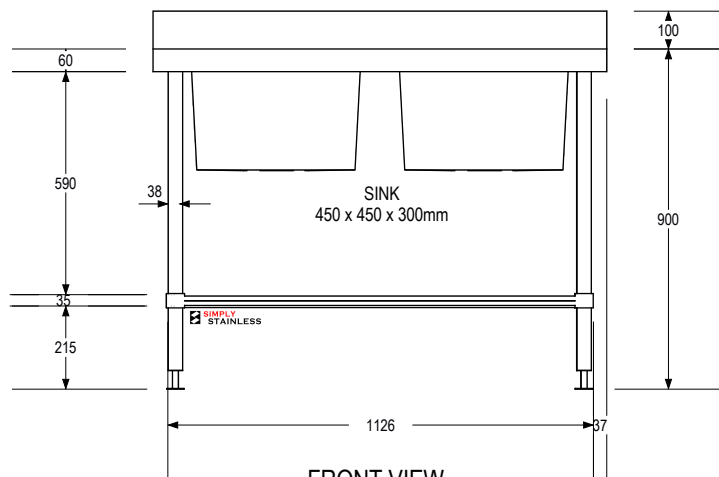

**FRONT VIEW**

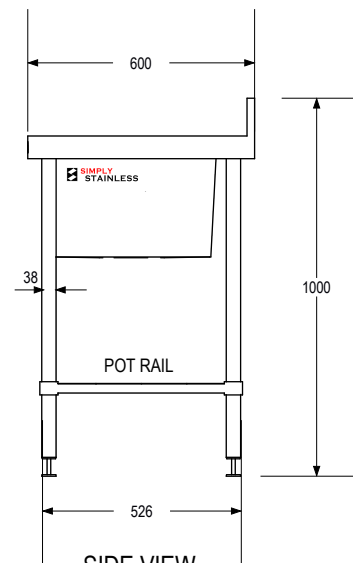

**SIDE VIEW**



www.simplystainless.com  
Modular Sinks Tables and Shelving

COPYRIGHT © 2016

This drawing is the property of CI GROUP PTY LTD. Tradings as SIMPLY STAINLESS and it may not be copied, reproduced or modified in whole or in part without prior written permission of CI GROUP PTY LTD.

**EU 06-6-1200 DOUBLE SINK  
BENCH**

scale 1:20

- FULL SS CONSTRUCTION NOTES :**
1. TOP MADE FROM 1.2mm STAINLESS STEEL.
  2. CHANNEL REINFORCING I & II MADE FROM 1.2mm STAINLESS STEEL.
  3. SINK MADE FROM 1.2mm STAINLESS STEEL.
  4. FRAME MADE FROM Ø38mm STAINLESS STEEL TUBE.
  5. POTRAIL MADE FROM STAINLESS STEEL ROUND TUBE.
  6. FEET ARE ADJUSTABLE STAINLESS STEEL DISC SHAPED FEET.