

Exploded View & Accessories

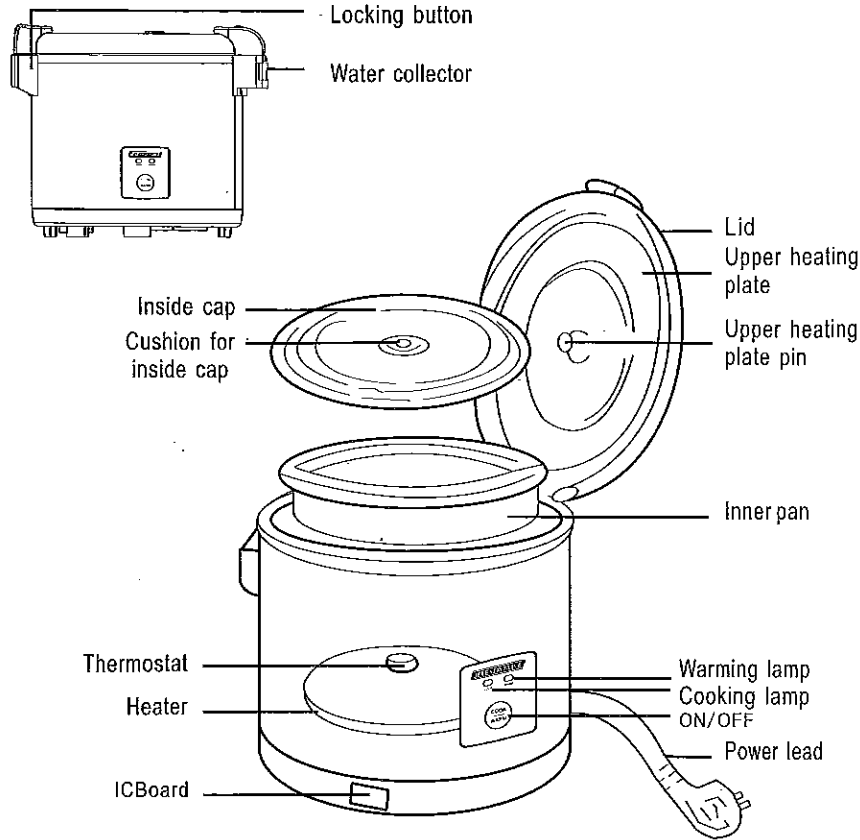

Water Collector

Pulling out the side will separate it from the main body. When attaching it to the main body again, be sure to insert it tightly. Drain the water out of the collector after cooking.

Accessories

Spoon

Measuring cup

Safety Instructions

Please read carefully

To prevent electric shock, fire, burns and operating problems, observe the following:

Inspect power lead and plug before you switch on cooker. Ensure that power lead is not twisted. Use only correct power outlet.

Checking

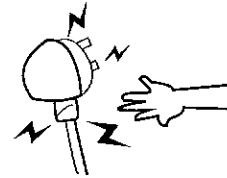

Hold plug firmly when disconnecting from power point.

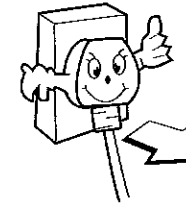

Do not lift cooker by its handle unless lid is securely locked.

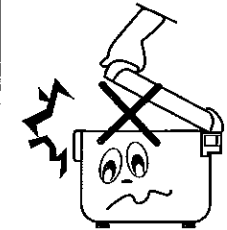

Do not place cooker near inflammable or combustible material.

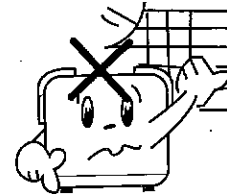

Be cautious of moisture. Do not expose the main body to water or any other liquid. Not even for cleaning purposes.

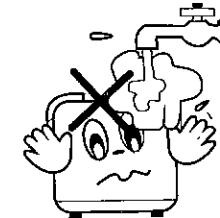

Be cautious of high temperatures during cooking. Do not touch the steam valve while cooking. Ensure that the valve is always unobstructed.

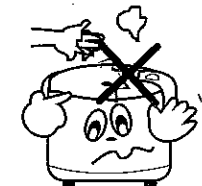

Do not use the cooker for any other purpose than cooking and warming rice. The cooker has been designed for this purpose only.

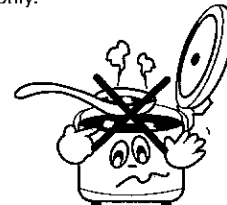

Ensure that foreign objects are kept away from the inside of the cooker.

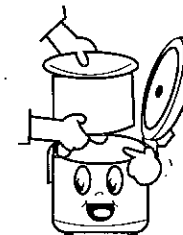

Position cooker securely on a level surface.

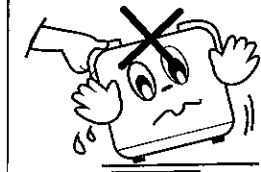

Cooking Directions

1. Fill the supplied measuring cup with rice as shown in drawing.

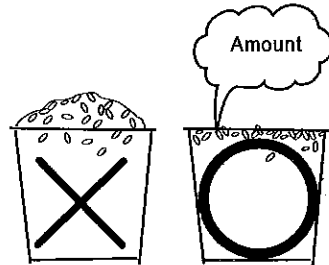

2. Rinse rice thoroughly in a dish other than the pan of the cooker.

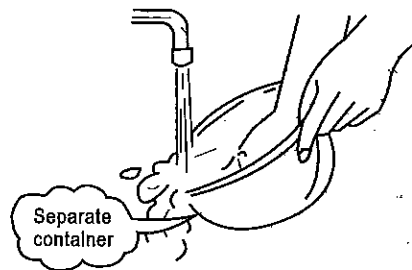

3. Pour washed rice into clean rice pan of the cooker and add the recommended amount of water. Use the supplied measuring cup to ascertain the correct amount. E.g. to cook 9 cups it is recommended that you fill the cup with water to level 9. (You may vary the amount of water to achieve results to your liking.)

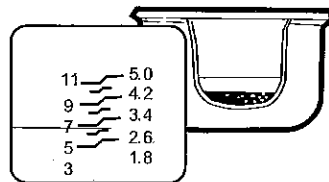

4. Inner pan into main pot as shown in the drawing.

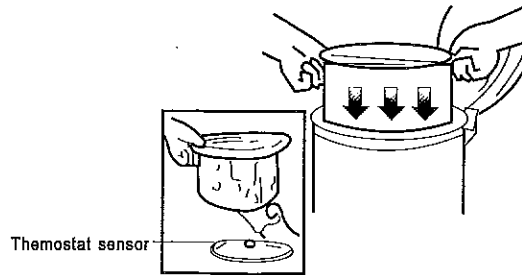

5. Insert cap of the pan into the lid of pot against the upper heating plate and lock into position.

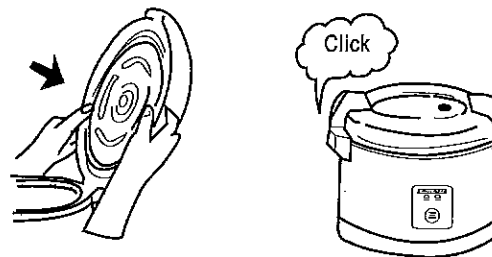

6. When the rice cooker is connected to a power source, the red "COOK" lamp will flash. Then press the button centre, the red lamp will stay on after 5 beeps. The rice cooker starts cooking now. For full capacity, it takes about 48 mins to cook (including 15 mins steaming the rice). When the rice is fully cooked and steamed, the red lamp goes off and orange "WARM" lamp is on. Now the rice cooker is in keep warm mode and ready to serve. Do not open the lid until cooking/steaming cycle is completed and orange lamp is on.

1. Red lamp flashes (power on)
2. Red lamp on (cooking)
3. Orange lamp on (keep warm)

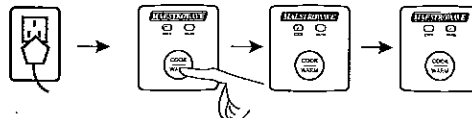

7. When cooking/steaming is completed, the "COOK" lamp will automatically switch off and the "WARM" lamp activates. Do not use pan beyond its minimum or maximum capacity. If the rice is cooked, the cooker is removed from power source and plugged again, you require to push the button twice to go back to the orange lamp for keep warm mode.

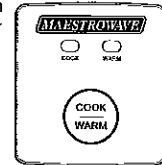

Time required for cooking and steaming is shown in minutes.

Measuring cup Model	3	5	7	9	11
MRC5L	32	36	40	45	48

8. Use the supplied spoon to stir the steamed rice well.

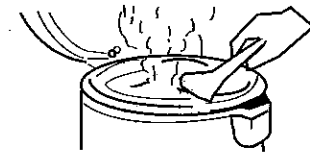

9. Caution
Disconnect cooker from power source only after heating and warming phase has been completed.



Tips & Hints

If you want to cook delicious rice

The amount of rice should be precisely measured using the measuring cup attached.

The most ideal capacity of the pan will be for 15~20 people.

Adjust the amount of water depending on the kinds of rice.

Be sure to check the amount of rice correctly and then, adjust the amount of water.

Kinds of rice	Amount of water
Ordinary rice (American long grain)	According to scales
Thai fragrant rice	higher than scales
Basmali rice	higher than scales

Continue to rinse the rice until the cleaning water looks clean.

- Rice not rinsed properly is likely to stick to the bottom of the pan.

SCORCHED RICE

The pan will produce a small amount of scorched rice, which enhances the taste of cooked rice. In any of the following cases, the amount of scorched rice may increase;

- When the rice was not rinsed fully
- When the rice was swollen in water for long
- When sugar or other food material was added to grain rice.

■ Cautions

Never use another manufacturers' pan other than this specified one.

Inner pan
(Do not use other ones than this authentic inner pan.)

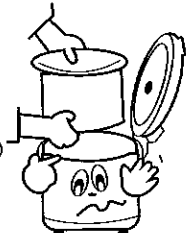

If you want to warm the cooked rice for good taste

Do not warm the cooked rice in any of the following cases;

- When the rice has not been fully rinsed
- When the cooked rice needs to be warmed for more than 12 hours
- When the cooked rice has once been cooled down
- When amount of cooked rice is small (below the minimum cooking amount)
- When other grains than white rice has been cooked (grain rice, soybean soup, curry, unpolished rice, porridge, etc)

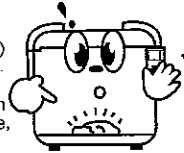

Increase the amount of water when the cooked rice needs to be warmed for a longer time.

The amount of moisture evaporated will increase over time. If you need to warm the cooked rice for any longer increase the amount of water that much.

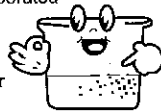

Do not fail to close the lid. If the lid is not closed securely the moisture will leak out reducing the effect of warming and thereby quality taste of cooked rice.

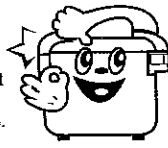

Do not leave the rice spoon in the pan during warming. The plastic smell of the spoon may infiltrate into the rice. Do not leave the spoon in the pan.

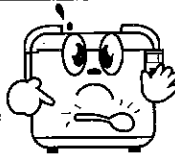

When the amount of the cooked rice is small, collect it in the center of the bottom, so that the drying effect may be minimized.



Maintenance

- Maintain the pan after pulling out the power plug and there by cooling down the pan sufficiently
- Clean such parts as inner pan and its cap, water collector and steam outlet thoroughly. They may be sources of bad smell. Do not use the pan to cook grains other than polished rice.

Out side and Inside of the Main Body Lid

Use a dry cloth to clean these parts after removing moisture. Finally, dry them with a dry and clean cloth.

Inner Pan and Its Cap

Use a sponge to clean out these parts. Do not scratch them.



Water Collector and Rice Spoon

Use a soft detergent to clean them and rinse them in clean water.

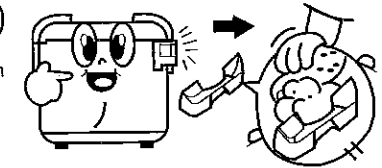

About Teflon Coating

- Use the specified rice spoon (made of plastic) in order to prolong the life of the pan and avoiding damage to surface.
- Do not cook or warm a vinegar-seasoned rice and other special rice. The inner pan may be subject to corrosion.
- The coated surface may be subject to stains, but this will not be any problem in terms of sanitary.

Before requesting After sales Service

<p>The cooked rice is</p> <ul style="list-style-type: none"> • too sticky • too thick • not steamed fully • not cooked fully 	<ul style="list-style-type: none"> • Did you use the correct amount of water and rice? • Is the bottom of the pan damaged or not even or is the • Thermostat sensor obstructed by rice grains or other objects? • Have you opened the lid, while the rice has yet to be steamed • Fully • Has the electricity gone out for a long time during cooking?
<p>The cooked rice in the pan is</p> <ul style="list-style-type: none"> • too hardened or • smells or • is discoloured as yellow 	<ul style="list-style-type: none"> • Have you warmed the rice for more than 12 hours or have you warmed a small amount of cooked rice or other grains than polished rice? • Did you leave the spoon in the pan or was the spoon contaminated with other food? • Did you rinse the rice thoroughly?

Specifications

The average temperature during warming is 23°C

Model	Power Supply	Cooking Capacity (min. ~ max.)	Rated consumption of electricity		Weight	Dimension	
			For cooking	For warming		width	height
MRC-5L	220-240V /50Hz	for 5~28 people	1950W	84W	8.5kg	380mm	335mm

For Service and Spares

Contact
RHHALL
 HALLCO HOUSE, BEACON COURT
 PITSTONE GREEN BUSINESS PARK
 PITSTONE, LEIGHTON BUZZARD
 BEDFORDSHIRE
 LU7 9GY
 UK

TEL 01296 663400

E-MAIL sales@rhhall.com

WEBSITE www.rhhall.com



hallco™

ELECTRONIC RICE COOKER & WARMER

DURABLE STAINLESS
 STEEL EXTERIOR

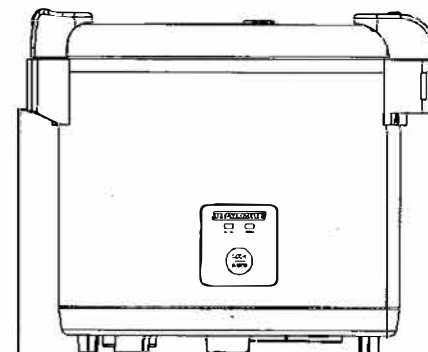
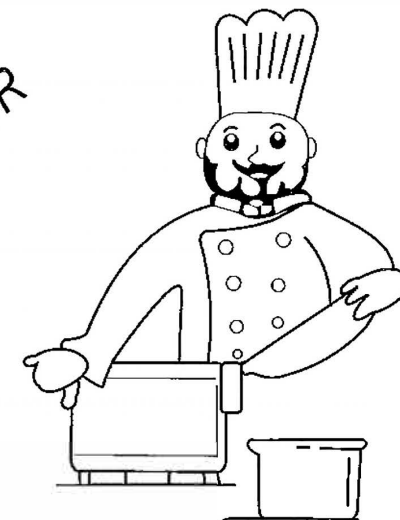

INSTRUCTION MANUAL MRC5L

Table of Contents	1
Exploded View & Accessories	1
Safety Instructions	2
Cooking Directions	3, 4
Tips & Hints	5
Maintenance	6
Before requesting After sales Service	7
Specifications	7