

**BOTTOM-PLAN VIEW (TOP ONLY)**

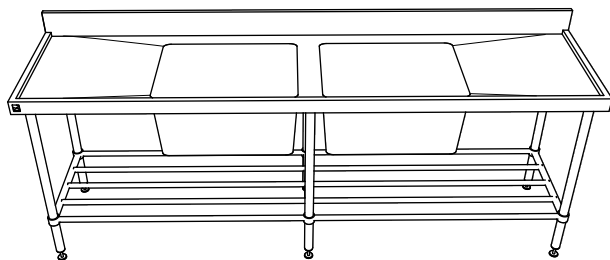

**ISOMETRIC VIEW**  
do not scale

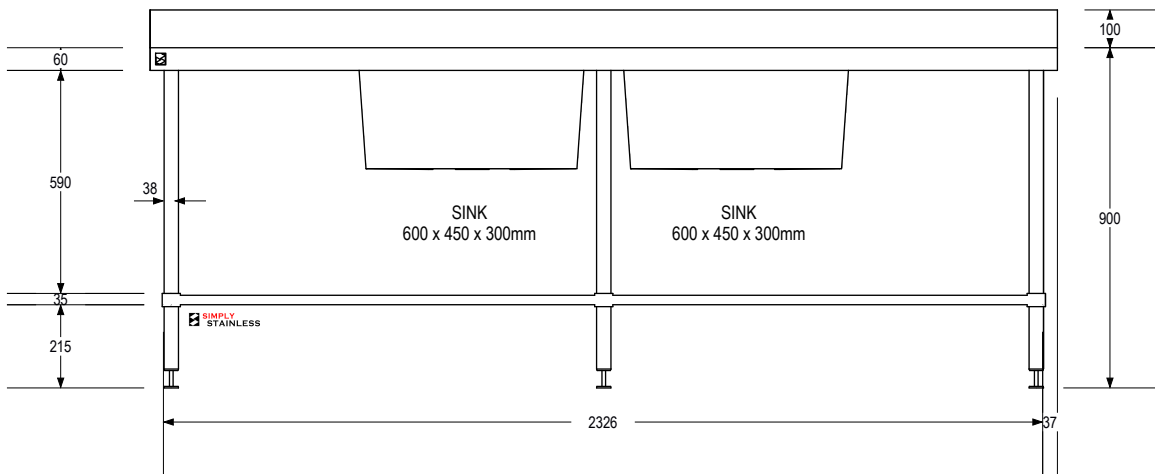

**FRONT VIEW**

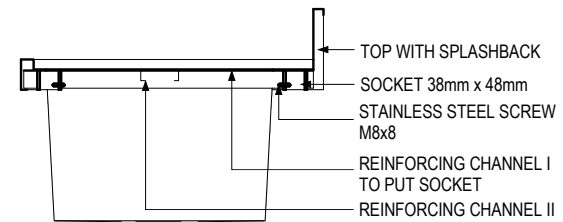
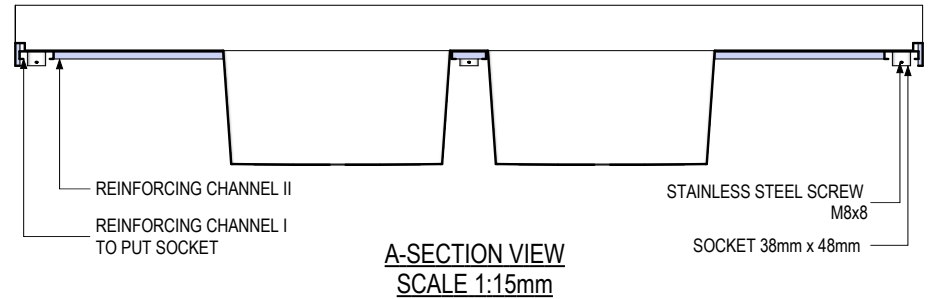

**B-SECTION VIEW**  
SCALE 1:15mm

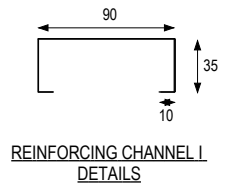

**REINFORCING CHANNEL I  
DETAILS**

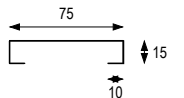

**REINFORCING CHANNEL II  
DETAILS**

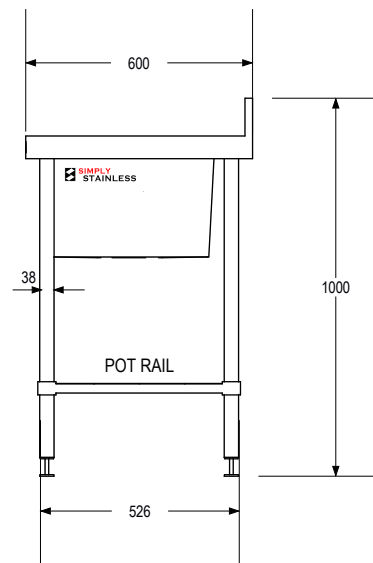

**SIDE VIEW**



www.simplystainless.com  
Modular Sinks Tables and Shelving

COPYRIGHT © 2016

This drawing is the property of CI GROUP PTY LTD. Tradings as SIMPLY STAINLESS and It may not be copied, reproduced or modified in whole or in part without prior written permission of CI GROUP PTY LTD.

**EU 06-6-2400 DOUBLE SINK  
BENCH**

scale 1:20

- FULL SS CONSTRUCTION NOTES :**
1. TOP MADE FROM 1.2mm STAINLESS STEEL.
  2. CHANNEL REINFORCING I & II MADE FROM 1.2mm STAINLESS STEEL.
  3. SINK MADE FROM 1.2mm STAINLESS STEEL.
  4. FRAME MADE FROM Ø38mm STAINLESS STEEL TUBE.
  5. POTRAIL MADE FROM STAINLESS STEEL ROUND TUBE.
  6. FEET ARE ADJUSTABLE STAINLESS STEEL DISC SHAPED FEET.