

BOTTOM-PLAN VIEW (TOP ONLY)

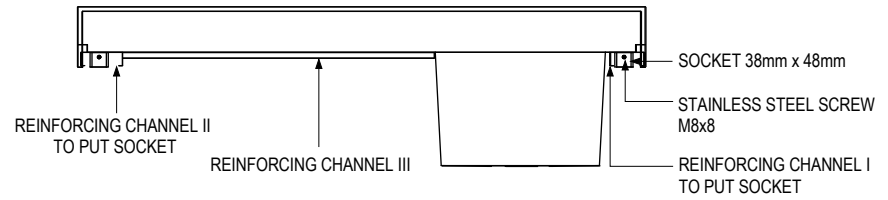

**A-SECTION VIEW
SCALE 1:15mm**

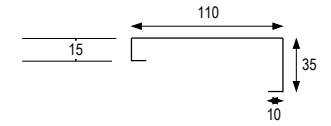

**REINFORCING CHANNEL I
DETAILS**

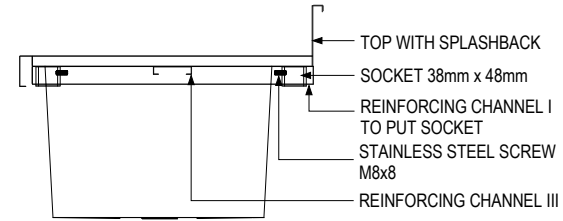

**B-SECTION VIEW
SCALE 1:15mm**

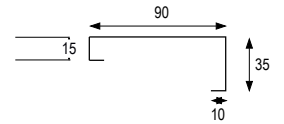

**REINFORCING CHANNEL II
DETAILS**

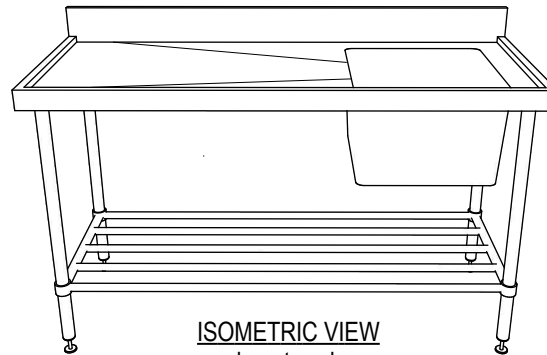

**ISOMETRIC VIEW
do not scale**

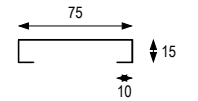

**REINFORCING CHANNEL III
DETAILS**

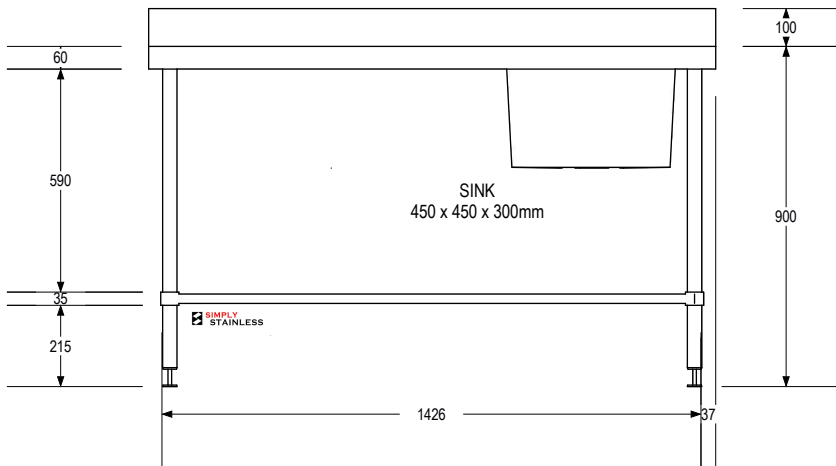

FRONT VIEW

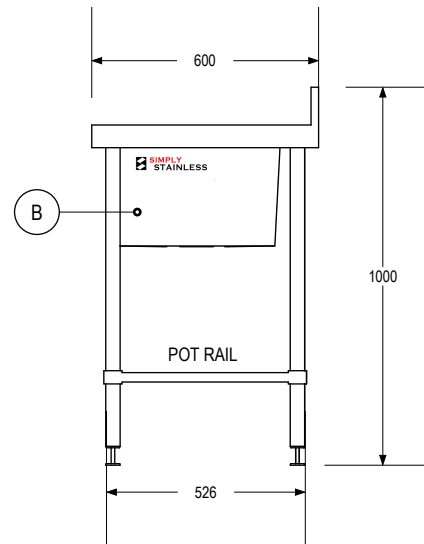

SIDE VIEW



www.simplystainless.com
Modular Sinks Tables and Shelving

COPYRIGHT © 2016

This drawing is the property of CI Group Pty Ltd. Trading as SIMPLY STAINLESS and It may not be copied, reproduced or modified in whole or in part without prior written permission of CI Group Pty Ltd. SIMPLY STAINLESS reserves the right to change specification and design without notice.

EU 05-6-1500R SINK BENCH

scale 1:20

- FULL SS CONSTRUCTION NOTES :**
1. TOP MADE FROM 1.2mm STAINLESS STEEL.
 2. CHANNEL REINFORCING I & II MADE FROM 1.2mm STAINLESS STEEL.
 3. SINK MADE FROM 1.2mm STAINLESS STEEL.
 4. FRAME MADE FROM Ø38mm STAINLESS STEEL TUBE.
 5. POTRAIL MADE FROM STAINLESS STEEL ROUND TUBE.
 6. FEET ARE ADJUSTABLE STAINLESS STEEL DISC SHAPED FEET.