

**BOTTOM-PLAN VIEW (TOP ONLY)**

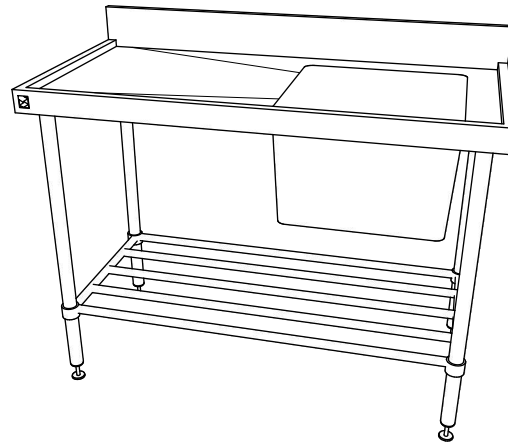

**ISOMETRIC VIEW**  
do not scale

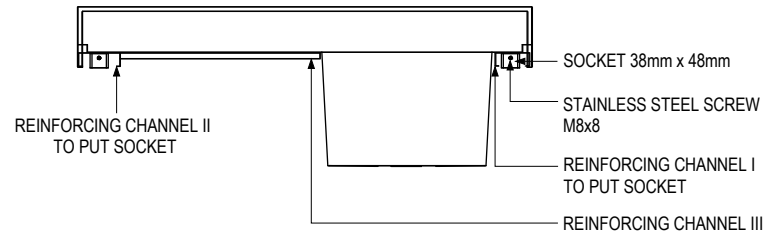

**A-SECTION VIEW**  
SCALE 1:15mm

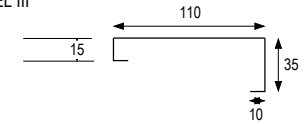

**REINFORCING CHANNEL I DETAILS**

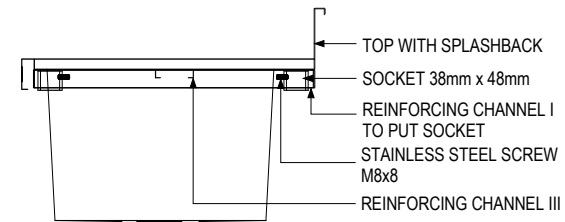

**B-SECTION VIEW**  
SCALE 1:15mm

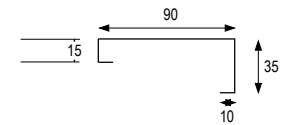

**REINFORCING CHANNEL II DETAILS**

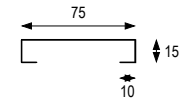

**REINFORCING CHANNEL III DETAILS**

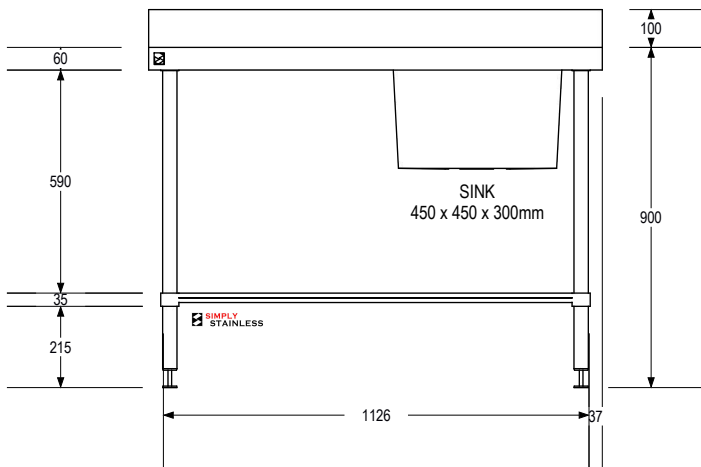

**FRONT VIEW**

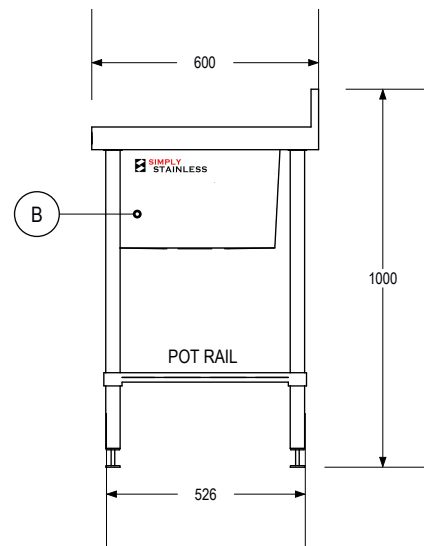

**SIDE VIEW**



**COPYRIGHT © 2016**

This drawing is the property of CI Group Pty Ltd. Trading as SIMPLY STAINLESS and It may not be copied, reproduced or modified in whole or in part without prior written permission of CI Group Pty Ltd. SIMPLY STAINLESS reserves the right to change specification and design without notice.

**EU 05-6-1200R SINK BENCH**

scale 1:20

**FULL SS CONSTRUCTION NOTES :**

1. TOP MADE FROM 1.2mm STAINLESS STEEL.
2. CHANNEL REINFORCING I & II MADE FROM 1.2mm STAINLESS STEEL.
3. SINK MADE FROM 1.2mm STAINLESS STEEL.
4. FRAME MADE FROM Ø38mm STAINLESS STEEL TUBE.
5. POTRAIL MADE FROM STAINLESS STEEL ROUND TUBE.
6. FEET ARE ADJUSTABLE STAINLESS STEEL DISC SHAPED FEET.